

● 7631
GERBER

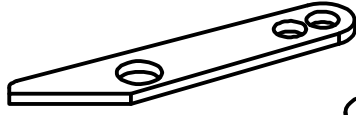

● 7632
KNITTING M/C



○ 7633

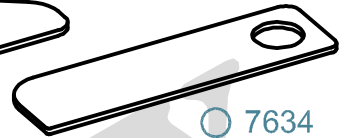

○ 7634
SHUTTLE WINDING

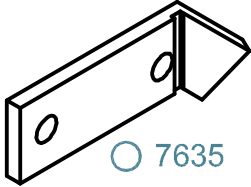

○ 7635

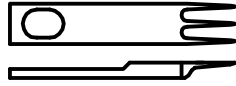

○ 7637

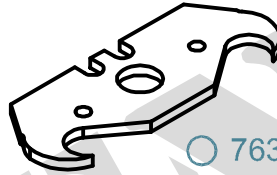

○ 7639

◎ ○ 7661

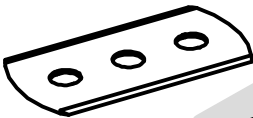

○ 7636

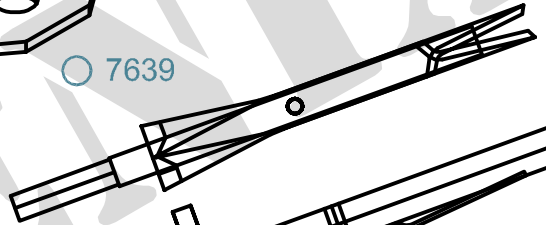
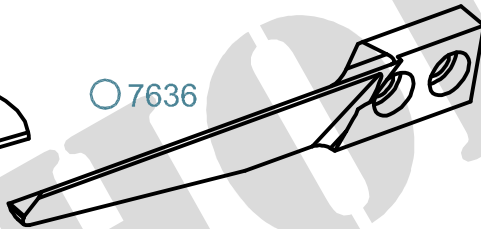

○ 7640-00
HAND TUFTING

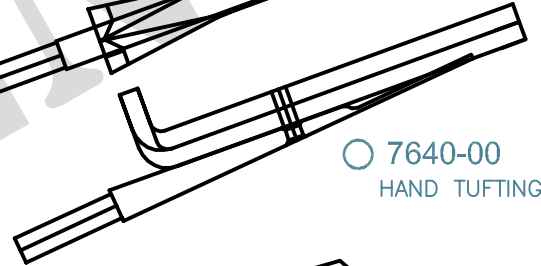

○ 7662
WRAP CUTTER

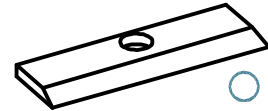
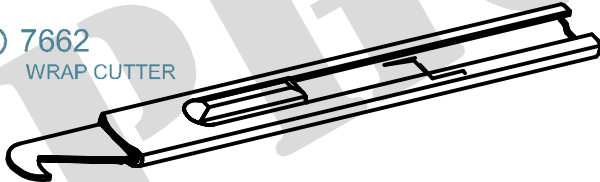

○ 7653

○ 7662

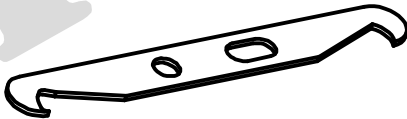

○ 7665

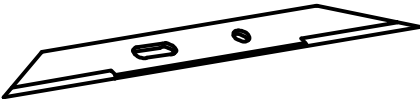

○ 7666
WRAP CUTTER

7666MH
7666H

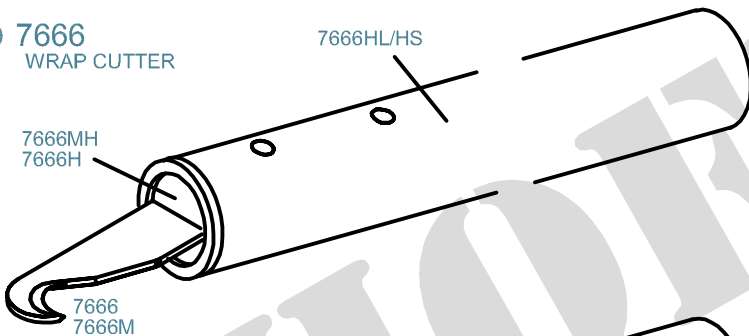

7666HL/HS

7666
7666M

○ 7666M
WRAP CUTTER

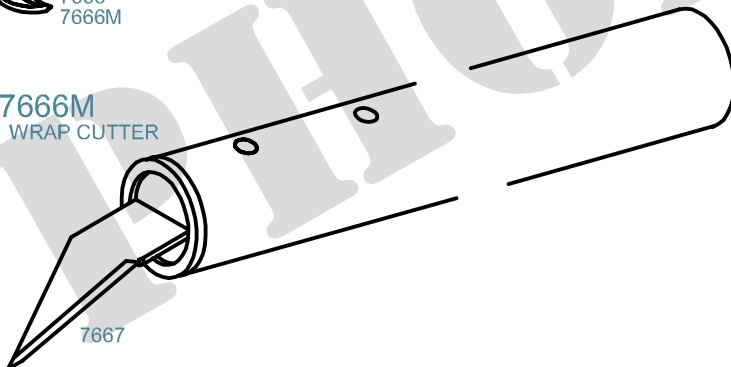

7667

MATERIAL CODE : ● SOLID CARBIDE , ○ HSS , ◐ BRAZED CARBIDE , ◎ TIN COATED